

KOMATSU

PW180-11



Hydraulic wheeled excavator

Engine power
123 kW / 165 HP @ 2000 rpm

Operating weight
17600 - 20600 kg

Bucket capacity
max. 1.13 m³



Engine power
123 kW / 165 HP @ 2000 rpm

Operating weight
17600 - 20600 kg

Bucket capacity
max. 1.13 m³

Exceptional workability and environmental performance

Powerful and environmentally friendly

- EU Stage V engine
- Adjustable idle shutdown
- Komatsu fuel-saving technology
- Excellent travel performance
- High lifting capacity



Total versatility

- Ideal for a wide range of applications
- Additional hydraulic circuit
- Komatsu Integrated Attachment Control (KIAC) (option)
- A wide choice of options

First-class operator comfort

- Premium air-suspended operator seat with integrated joystick consoles (option)
- Boom suspension system (ECSS) (option)
- KomVision surround view system
- Improved widescreen monitor
- Optional joystick steering system

State-of-the-art controls

- Proportional controls for attachments
- Improved, ergonomic switches
- 6 working modes

Easy maintenance

- Improved service access
- Extended undercarriage maintenance interval
- Centralised greasing system
- User-friendly location of the electric refuelling pump
- Simple access to the AdBlue® tank

Komtrax

- Komatsu Wireless Monitoring System
- 4G mobile communications
- Increased operational data and fuel savings
- Integrated communication antenna



A maintenance program for Komatsu customers



Higher productivity

Along with its compact size, the PW180-11 features an unrivalled lifting performance. The combination of power, weight distribution, convenient dimensions and complete control makes it the top choice for heavy-duty lifting applications, simple excavating tasks in narrow alleys, and for road and sewer construction sites.

Komatsu fuel-saving technology

Fuel consumption on the PW180-11 is lower by up to 3% vs previous model. Engine management is enhanced. The variable speed matching of the engine and hydraulic pumps guarantee efficiency and precision during single and combined movements. A viscous clutch enables variable cooling fan speed to further reduce fuel consumption.

Adjustable idle shutdown

The Komatsu auto idle shutdown automatically turns off the engine after it idles for a set period of time. This feature can easily be programmed from 5 to 60 minutes, to reduce unnecessary fuel consumption and exhaust emissions, and to lower operating costs. An Eco-gauge and the Eco guidance tips on the cab monitor further encourage efficient operations.

Powerful and environmentally friendly



Komatsu EU Stage V

The Komatsu EU Stage V engine is productive, dependable and efficient. With ultra-low emissions, it provides a lower environmental impact and a superior performance to help reduce operating costs and lets the operator work in complete peace of mind.

Heavy-duty aftertreatment

The aftertreatment system combines a Komatsu Diesel Particulate Filter (KDPF) and Selective Catalytic Reduction (SCR). The SCR injects the correct amount of AdBlue® into the system at the proper rate to break down NOx into water (H₂O) and non-toxic nitrogen gas (N₂). NOx emissions are reduced by 80% vs, EU Stage IIIB engines.

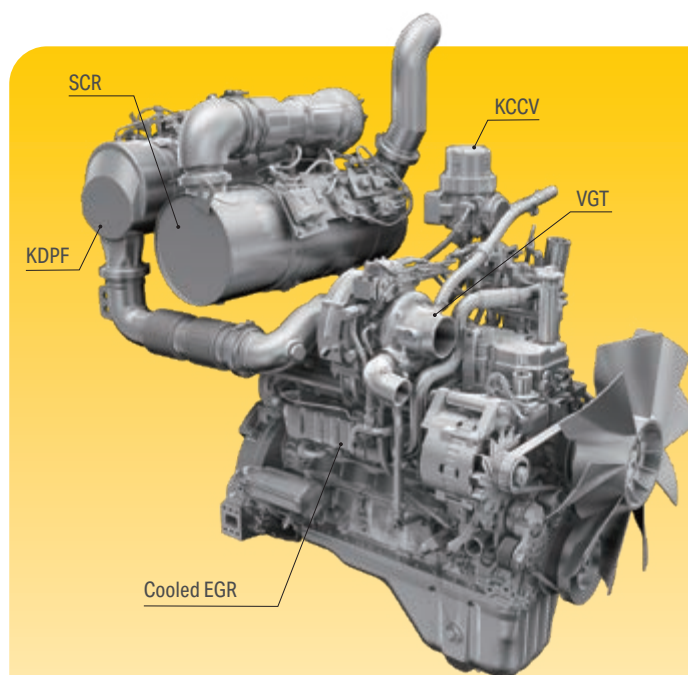
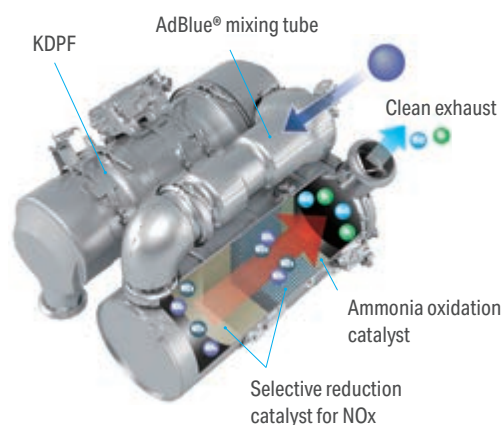

High-Pressure Common Rail (HPCR)

To achieve complete fuel burn and lower exhaust emissions, the heavy-duty High-Pressure Common Rail fuel injection system is computer controlled to deliver a precise quantity of pressurised fuel into the redesigned engine combustion chamber by multiple injections.

Exhaust Gas Recirculation (EGR)

Cooled EGR is a technology well-proven in current Komatsu engines. The increased capacity of the EGR cooler now ensures very low NOx emissions and a better engine performance.

Komatsu Closed Crankcase Ventilation (KCCV)

Crankcase emissions (blow-by gas) are passed through a CCV filter. The oil mist trapped in the filter is returned back to the crankcase while the filtered gas is returned to the air intake.

Variable Geometry Turbo (VGT)

The VGT provides optimal airflow to the engine combustion chamber under all speed and load conditions. Exhaust gas is cleaner, fuel economy is improved while machine power and performance are maintained.

PW180-11

Ideal for a wide range of applications

Powerful and precise, the Komatsu PW180-11 is equipped to efficiently carry out any task your business requires. On big sites or small, for digging, trenching, landscaping or site preparation, the Komatsu original equipment hydraulic system always ensures maximum productivity and control.

Additional hydraulic circuit

To allow the use of many attachments, such as buckets, breakers or clamshell buckets, an additional hydraulic circuit controlled by a sliding joystick button is standard on the PW180-11. To further increase versatility and flexibility, a second optional auxiliary circuit and an optional hydraulic quick-coupler actuation are also available. In combination with the Komatsu Integrated Attachment Control (KIAC), changing and operating different attachments becomes child's play.



Total versatility



Total versatility



Quick-couplers

Lehnhoff quick-couplers – mechanical, hydraulic or fully hydraulic – are available for factory installation. They can turn an excavator into a multi-functional tool carrier for any type of attachment. All quick-couplers offer high functional safety thanks to their sealed locking mechanisms and hydraulics. The Lehmatic Safety Control (LSC) assistant system is integrated into the machine's monitor and gives the operator full control of the Lehnhoff quick coupler's locking status.



Automatic digging brake

This new optional digging brake automatically activates the service brake and oscillation lock when the machine stops, and it releases them when the machine accelerates again. The operator can fully focus on the job with no need to step on the brake.



Trailer hitch

For increased versatility, the PW180-11 can be equipped with either a car ball type hitch, an agricultural ball type hitch, or a truck type automatic hitch, for trailers up to 7.5 tonnes with an overrun brake. All necessary electric and hydraulic hook-ups are provided, including two auxiliary undercarriage circuits for dumping or tail-gate operation. These trailer functions can be operated from the cab joysticks.

Boom suspension system (ECSS)

An optional electrical controlled suspension system (ECSS) for the boom provides a significant increase in comfort when traveling over bumps.

Standard or wide axles

No matter the job, with a small turning radius and excellent traction the axles are built for a maximum performance. For even better stability a 2750 mm wide axle is available. If more traction is needed, an optional 35% differential lock helps to get over rough terrain. To keep the machine cleaner, robust fenders are also available as option.





Komatsu Integrated Attachment Control (KIAC)



Adjustable oil flow

Komatsu Integrated Attachment Control (KIAC) (option)

For fast and safe tool changes without leaving the cab, the settings for oil flow and pressure of up to 15 hydraulic attachments are available as presets directly on the monitor panel. Komatsu Integrated Attachment Control (KIAC) includes adjustments for the first and second (optional) hydraulic circuits. Selecting the breaker mode automatically cuts all pressure in the return line.



Increased comfort

The SpaceCab™ provides an ergonomic and quiet work environment, with an outstanding view of the jobsite. ROPS certified, it was specifically designed by Komatsu for hydraulic excavators, with a reinforced pipe-structured framework set up on viscous damper mounts for low vibration levels. The standard telescopic steering wheel is comfortably adjustable in height and reach.

Improved operator convenience

With increased in-cab storage space, an auxiliary input (MP3 jack) and 12 V and 24 V power supply, the cab offers maximum convenience. The automatic air conditioner allows the operator to easily and precisely set the cab's atmosphere.

Premium comfort seat (option)

The premium comfort seat comes with suspended joystick consoles, top quality cushioning, auto weight adjustment, pneumatic lumbar support and a climate control system for perfect seat temperature adjustment.

Low-noise design

Komatsu wheeled excavators have very low external noise levels and are especially well-suited for work in confined spaces or urban areas. The optimal usage of sound insulation and of sound absorbing materials helps to make noise levels inside the cab comparable to those of an executive car.



Premium comfort seat (option)



Exceptionally good overview of the surroundings from the cab

First-class comfort

Easy operation

The Komatsu PW180-11 features an operational concept that puts full control of the machine right at the operator's fingertips. Different camera views, undercarriage attachments and the manual axle lock can all be actuated by buttons on top of the operational levers. Without removing the hand from the joystick, the operator can switch from boom operation to undercarriage control for complete and precise control over the parallel dozer blade.



Ergonomically designed switches that light up for safe and easy night operation



Ergonomic joysticks with proportional controls

Proportional controls

The ergonomic joysticks with proportional controls were specially redesigned and developed for working with a wheeled excavator. They have horizontal sliders for the first and second (optional) hydraulic circuits and offer safe and precise operation of attachments such as ditch cleaning buckets, sorting grapples, clamshell buckets, tilt rotators and of many other hydraulic attachments that require very fine control.

6 working modes

The PW180-11 delivers the required power with the lowest fuel consumption. 6 working modes are available: Power, Lifting/Fine Operation, Breaker, Economy, Attachment Power and Attachment Economy. The operator can ideally balance the Economy mode between power and economy to match the work at hand.



Joystick steering

With the optional joystick steering the operator can precisely fingertip control the machine on any jobsite. This allows the easy combined operation of driving and working with the attachment simultaneously.



An evolutionary interface

Helpful information is now easier than ever to find and understand with the upgraded monitor interface. An optimal main screen for the ongoing work can be selected simply by pressing the F6 key.

Lower operating costs

Komatsu ICT contributes to the reduction of operating costs by assisting to comfortably and efficiently manage operations. It raises the level of customer satisfaction and the competitive edge of our products.

Widescreen monitor

Installed with a choice of 26 languages, the widescreen monitor with simple switches and multifunction keys gives fingertip access to a large range of functions and operating info.

Equipped with universal piping for attachments such as breakers, the conversion to a low-pressure mode requires only a push of the breaker mode switch on the monitor.



Quick view on the operation logs



With KomVision, various camera view options help to maintain a constant bird's eye view from above the machine



Operator identification function

Information & communication technology



Knowledge

You get quick answers to basic and critical questions about your machines – what they're doing, when they did it, where they're located, how they can be used more efficiently and when they need to be serviced. Performance data is relayed by wireless communication technology (satellite, GPRS or 4G depending on model) from the machine to a computer and to the local Komatsu distributor – who's readily available for expert analysis and feedback.

Convenience

Komtrax enables convenient fleet management on the web, wherever you are. Data is analysed and packaged specifically for effortless and intuitive viewing in maps, lists, graphs and charts. You can foresee eventual maintenance issues and required spare parts, and troubleshoot a problem before Komatsu technicians arrive on site.



The way to higher productivity

Komtrax uses the latest wireless monitoring technology. Compatible on PC, smartphone or tablet, it delivers insightful and cost saving information about your fleet and equipment, and offers a wealth of information to facilitate peak machine performance. By creating a tightly integrated web of support it allows proactive and preventive maintenance and helps to efficiently run a business.

Power

The detailed information that Komtrax puts at your fingertips 24 hours a day, 7 days a week gives the power to make better daily and long-term strategic decisions – at no extra cost. Problems can be anticipated, maintenance schedules customised, downtime minimised and machines kept where they belong: working on the jobsite.



Safety first



Exceptional operator protection



KomVision cameras



Handrails and anti-slip plates

Optimal jobsite safety

Safety features on the Komatsu PW180-11 comply with the latest industry standards and work in synergy to minimise risks to people in and around the machine. A neutral detection system for travel and work equipment levers increase jobsite safety, along with a seat belt caution indicator and an audible travel alarm. Highly durable anti-slip plates – with additional high friction covering – maintain long term traction performance.

KomVision

With a series of high definition networked cameras fitted on the machine, KomVision provides a crystal clear, real-time bird's eye view of the immediate surroundings on the widescreen cab monitor. The operator can quickly and easily check the machine's vicinity prior to making any movement, and focus on the work at hand even in low light conditions.

Safe maintenance

Thermal guards around high temperature areas of the engine, protected fan belt and pulleys, a pump/engine partition that prevents hydraulic oil from spraying onto the engine, and exceptionally sturdy handrails: in Komatsu tradition, the highest safety level is provided for a fast and smooth maintenance.

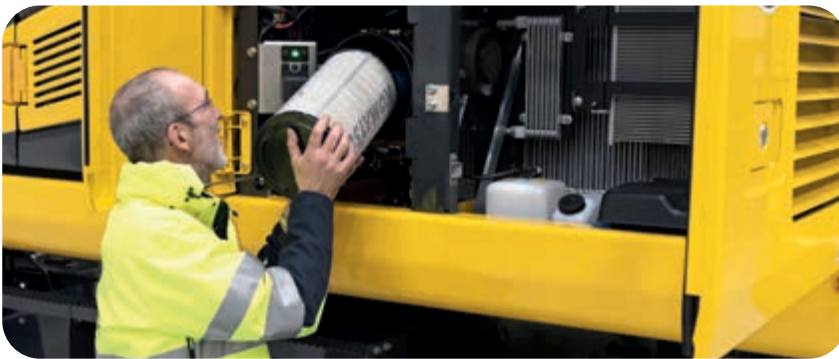

Easy maintenance

Simple and convenient service

The large doors and engine hood give convenient access to all daily service points. Filters are centralised and required service intervals are longer to keep machine downtime to a minimum.

Remote greasing bar

The PW180-11 features a centralised system that facilitates the regular greasing of the boom. An optional fully automatic greasing system can handle the regular and proper greasing of the complete machine – prolonging the lifetime and increasing the resale value of the excavator.

Electric refuelling pump

Standard equipment on all PW180-11 includes an automatic shut-off fuelling pump that allows easy refuelling from a barrel.

Easy radiator access

Thanks to a side-by-side cooler arrangement, the aftercooler and hydraulic oil radiator can be cleaned easily and repaired individually in case of damage.

Komatsu Care

Komatsu Care is a maintenance program that comes as standard with your new Komatsu machine. It covers factory-scheduled maintenance, performed with Komatsu Genuine parts by Komatsu-trained technicians. It also offers extended coverage of the Komatsu Diesel Particulate Filter (KDPF) and of the Selective Catalytic Reduction (SCR). Please contact your local Komatsu distributor for terms and conditions.

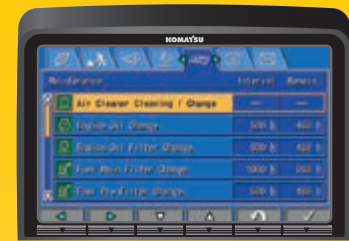

Basic maintenance screen

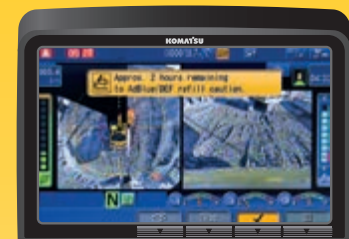

AdBlue® level and refill guidance



Simple access to the AdBlue® tank



Automatic greasing system (option)



Specifications

PW180-11E0

Engine

Model	Komatsu SAA6D107E-3
Type	Common rail direct injection, water-cooled, emissionised, turbocharged, after-cooled diesel
Engine power	
at rated engine speed	2000 rpm
ISO 14396	123 kW / 165 HP
ISO 9249 (net engine power)	118 kW / 158 HP
No. of cylinders	6
Bore × stroke	107 × 124 mm
Displacement	6.69 l
Air filter type	Double element type with monitor panel dust indicator and auto dust evacuator
Cooling	Suction type cooling fan with radiator fly screen
Fuel	Diesel fuel, conforming to EN590 Class 2/ Grade D, Paraffinic fuel capability (HVO, GTL, BTL), conforming to EN 15940:2016

Hydraulic system

Type	HydrauMind, Closed-centre system with load sensing and pressure compensation valves
Additional circuits	Depending on the specification up to 2 additional proportional control & quick-coupler circuits can be installed
Main pump	Variable displacement piston pump supplying boom, arm, bucket, swing and travel circuits
Maximum pump flow	288.4 l/min
Relief valve settings	
Implement	380 kg/cm ²
Travel	420 kg/cm ²
Swing	290 kg/cm ²
Pilot circuit	36 kg/cm ²

Swing system

Type	Axial piston motor driving through planetary double reduction gearbox
Swing lock	Electrically actuated wet multi-disc brake integrated into swing motor
Swing speed	0 - 11.5 rpm
Swing torque	43 kNm

Steering system

Steering control	Hydraulic steering system supplied from a separate gear pump and controlled through LS orbitrol & priority valves
Minimum turning radius	6800 mm (to center of outer wheel)

Brake system

Type	Dual circuit hydraulic braking system supplied from a separate gear pump
Service brakes	Pedal actuated wet multi-disc brakes integrated into the axle hubs
Parking brake	Electrically actuated wet multi-disc "spring actuation hydraulic release" brake integrated into the transmission

Transmission

Type	Fully automatic power shift transmission with permanent 4 wheel drive
Travel motors	One variable displacement axial piston motor
Maximum pressure	380 bar
Travel modes	Automatic + 3 travel modes
Max. travel speeds	
Hi / Lo / Creep	35.0 / 10.0 / 2.5 km/h
	A max. speed restriction of 20 km/h is available as an option
Maximum drawbar pull	10900 kg
Axle oscillation	10° Lockable in any position from the operator cab

Service refill capacities

Fuel tank	310 l
Radiator	35 l
Engine oil	23.1 l
Swing drive	5.5 l
Hydraulic tank	167 l
Transmission	3.0 l
Front differential	9.5 l
Rear differential	12.4 l
Front axle hub	2.5 l
Rear axle hub	2.5 l
Swing pinion grease bath amount	10.5 l
AdBlue® tank	29.6 l

Environment

Engine emissions	Fully complies with EU Stage V exhaust emission regulations
Noise levels	
LwA external	101 dB(A) (2000/14/EC Stage II)
LpA operator ear	69 dB(A) (ISO 6396 dynamic test)
Vibration levels (EN 12096:1997)	
Hand/arm	≤ 2.5 m/s ² (uncertainty K = 0.49 m/s ²)
Body	≤ 0.5 m/s ² (uncertainty K = 0.16 m/s ²)
Contains fluorinated greenhouse gas HFC-134a (GWP 1430).	
Quantity of gas 0.9 kg; CO ₂ equivalent 1.29 t	

Operating weight (appr.)

Undercarriage attachment type	Mono boom	Two-piece boom
Without	17740 kg	17910 kg
Rear blade	18595 kg	18765 kg
Rear outrigger	18810 kg	18980 kg
2 outriggers + blade	19670 kg	19840 kg
4 outriggers	19880 kg	20050 kg

Operating weight, including specified work equipment, 2600 mm arm, operator, lubricant, coolant, full fuel tank, bucket (530 kg) and the standard equipment.

Max. bucket capacity and weight

Arm length	Mono boom		
	2250 mm	2600 mm	2900 mm
Material weight up to 1.2 t/m ³	1.13 m ³ 675 kg	1.04 m ³ 645 kg	0.94 m ³ 615 kg
Material weight up to 1.5 t/m ³	0.94 m ³ 615 kg	0.85 m ³ 585 kg	0.75 m ³ 525 kg
Material weight up to 1.8 t/m ³	0.85 m ³ 585 kg	0.75 m ³ 525 kg	0.66 m ³ 495 kg

Arm length	Two-piece boom		
	2250 mm	2600 mm	2900 mm
Material weight up to 1.2 t/m ³	1.13 m ³ 675 kg	1.04 m ³ 645 kg	0.94 m ³ 615 kg
Material weight up to 1.5 t/m ³	0.94 m ³ 615 kg	0.85 m ³ 585 kg	0.75 m ³ 525 kg
Material weight up to 1.8 t/m ³	0.85 m ³ 585 kg	0.75 m ³ 525 kg	0.66 m ³ 495 kg

Max. capacity and weight have been calculated according to ISO 10567:2007.

Please consult with your distributor for the correct selection of buckets and attachments to suit the application.

Bucket and arm force

Arm length	2250 mm	2600 mm	2900 mm
Bucket digging force	10200 kg (115 kN)	10200 kg (115 kN)	10200 kg (115 kN)
Bucket digging force at PowerMax	12500 kg (123 kN)	12500 kg (123 kN)	12500 kg (123 kN)
Arm crowd force	9100 kg (89 kN)	8200 kg (80 kN)	7600 kg (74 kN)
Arm crowd force at PowerMax	9700 kg (95 kN)	9000 kg (88 kN)	8100 kg (79 kN)

Dimensions and performance figures

Mono boom

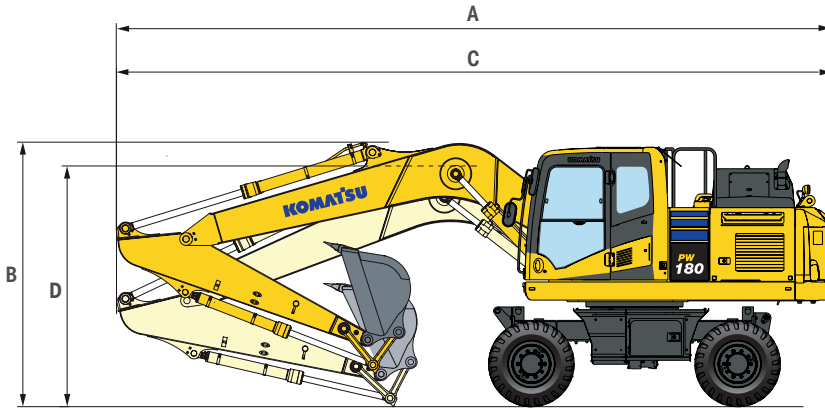

Driving position

Arm length	A	B
2250 mm	8930 mm	3565 mm
2600 mm	8930 mm	3565 mm
2900 mm *	8930 mm	3565 mm

Transport position

Arm length	C	D
2250 mm	8970 mm	3155 mm
2600 mm	8975 mm	3170 mm
2900 mm	8985 mm	3255 mm

* Driving position without bucket

Two-piece boom

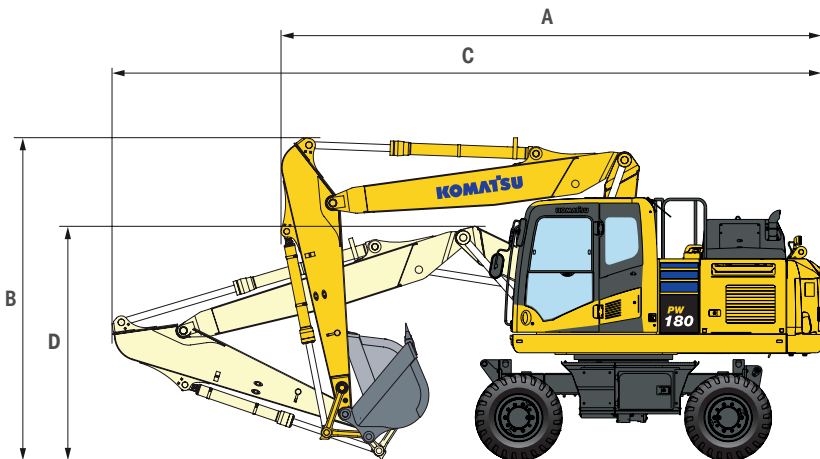

Driving position

Arm length	A	B
2250 mm	6740 mm	3945 mm
2600 mm	6745 mm	3945 mm
2900 mm *	6780 mm	3945 mm

Transport position

Arm length	C	D**
2250 mm	8910 mm	3085 mm
2600 mm	8905 mm	3145 mm
2900 mm	8875 mm	3240 mm

* Driving position without bucket

** Height to top of hose

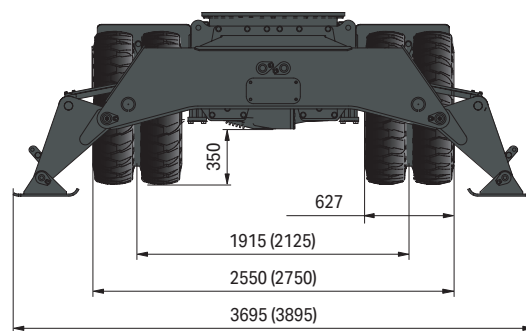
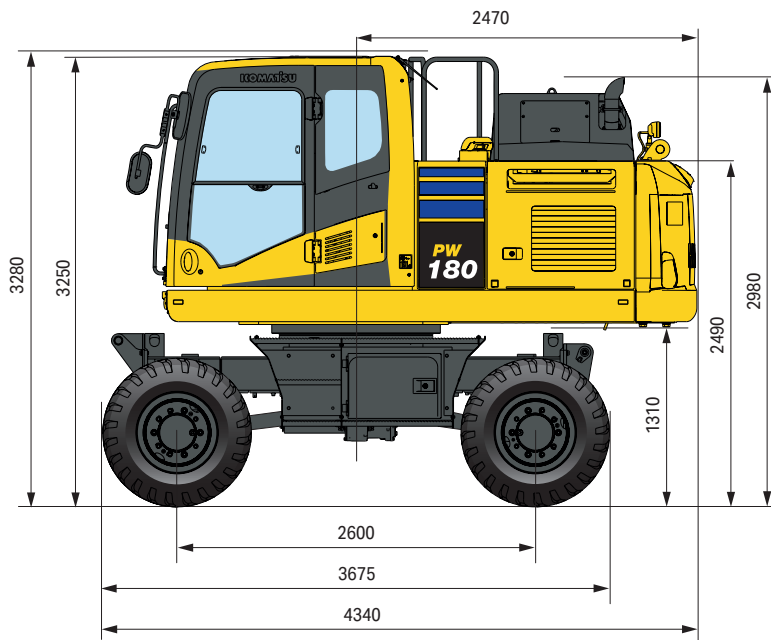

All dimensions with tyres Bandenmarkt Excavator 315/70 R225

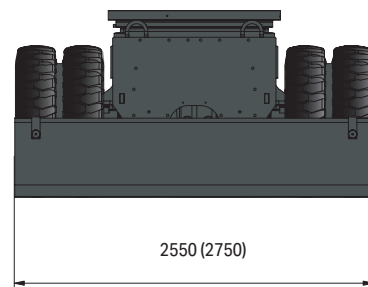

(): Figures for 2.75 m undercarriage

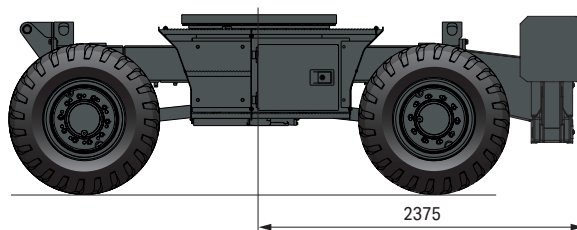
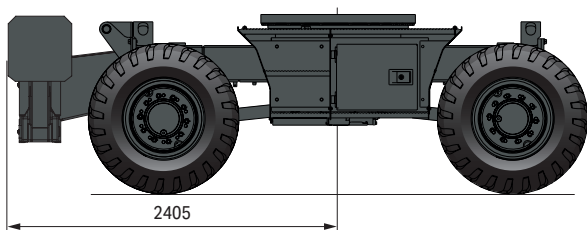
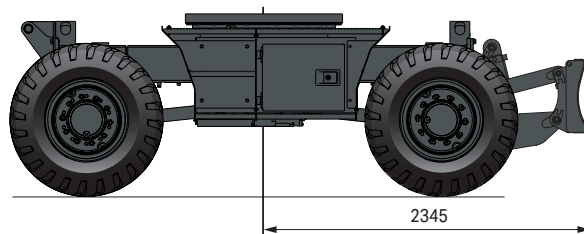
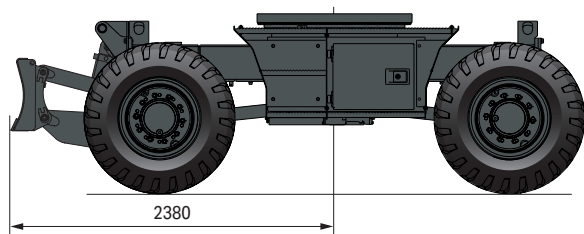

Working range

Mono boom

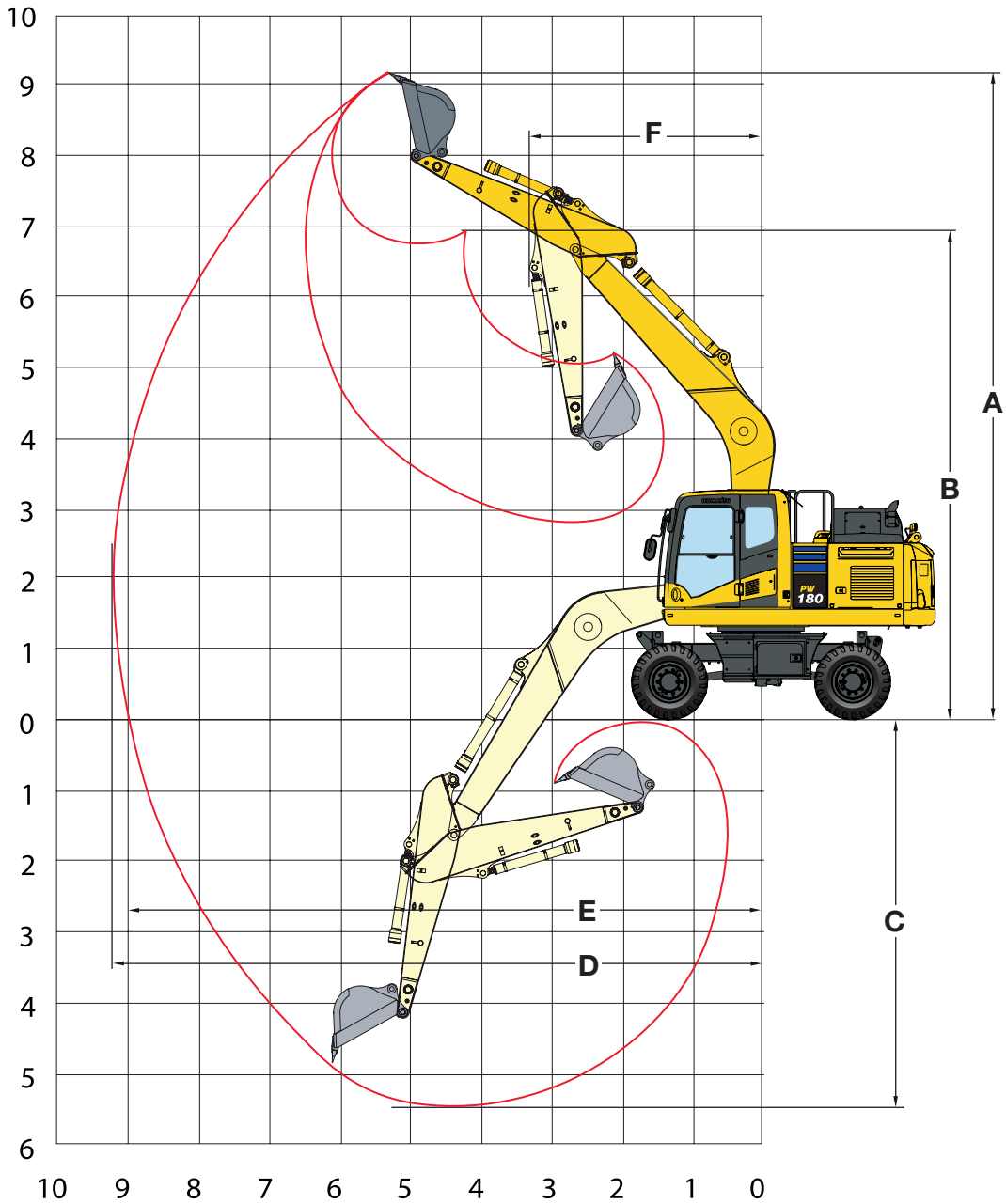

Arm length	2250 mm	2600 mm	2900 mm
A Max. digging height	9458 mm	9562 mm	9756 mm
B Max. dumping height	6915 mm	7064 mm	7236 mm
C Max. digging depth	5321 mm	5676 mm	5966 mm
D Max. digging reach	9061 mm	9345 mm	9929 mm
E Max. digging reach at ground level	8907 mm	9227 mm	9509 mm
F Min. swing radius	3543 mm	3829 mm	4057 mm

Two-piece boom

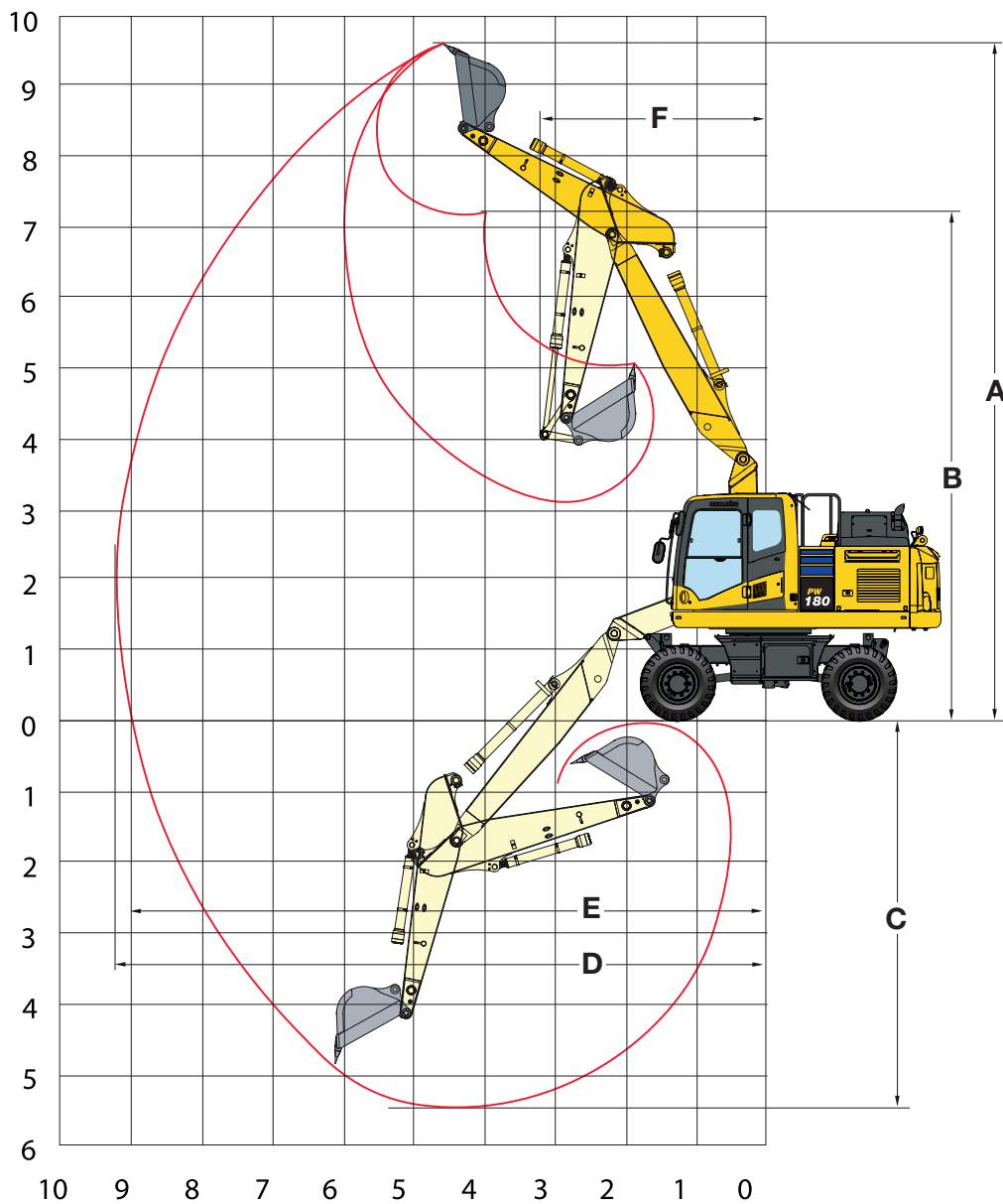



Arm length

	2250 mm	2600 mm	2900 mm
A Max. digging height	9942 mm	10129 mm	10350 mm
B Max. dumping height	7283 mm	7489 mm	7709 mm
C Max. digging depth	5400 mm	5742 mm	6044 mm
D Max. digging reach	9080 mm	9401 mm	9683 mm
E Max. digging reach at ground level	8907 mm	9227 mm	9509 mm
F Min. swing radius	3065 mm	3311 mm	3511 mm

Lifting capacity / mono boom / undercarriage width 2.55 m

Arm length	A B	⊗		7.5 m		6.0 m		4.5 m		3.0 m		1.5 m			
		⊗	⊗	⊗	⊗	⊗	⊗	⊗	⊗	⊗	⊗	⊗	⊗		
 <p>Without stabilizer</p>	2250 mm	7.5 m	kg	*3350	*3350					*5150	4800				
		6.0 m	kg	*3000	2450			4150	3000	*5600	4800				
		4.5 m	kg	2850	2000	2850	2000	4050	2900	6350	4500	*8150	*8150		
		3.0 m	kg	2550	1800	2750	1950	3900	2750	5950	4150				
		1.5 m	kg	2400	1700	2700	1900	3700	2550	5550	3800				
		0.0 m	kg	2450	1750	2600	1800	3550	2450	5300	3600				
		-1.5 m	kg	2750	1900			3500	2400	5250	3550	*9100	6400		
		-3.0 m	kg	3350	2350			3550	2450	5300	3600	*8500	6550		
		-4.5 m	kg												
	2600 mm	7.5 m	kg	*2750	*2750										
		4.5 m	kg	*2550	2250			4200	3050						
		3.0 m	kg	*2450	1850	2850	2000	4050	2950	*6050	4600				
		1.5 m	kg	2400	1650	2750	1950	3900	2750	6000	4200				
		0.0 m	kg	2250	1600	2650	1850	3650	2550	5550	3800				
		-1.5 m	kg	2250	1600	2550	1800	3500	2400	5250	3550	*5600	*5600		
		-3.0 m	kg	2400	1750	2550	1750	3450	2400	5200	3450	*8950	6300		
		-3.0 m	kg	3000	2100			3450	2400	5250	3500	*9450	6400		
		-4.5 m	kg												
	2900 mm	7.5 m	kg	*2350	*2350			*3000	*3000						
		4.5 m	kg	*2150	2050			*4100	3000						
		3.0 m	kg	*2100	1700	2800	1950	4050	2900	*5050	4600				
		1.5 m	kg	*2150	1500	2700	1900	3850	2700	6000	4200	11750	7700		
		0.0 m	kg	2100	1450	2600	1800	3650	2550	5550	3800				
		-1.5 m	kg	2150	1500	2500	1700	3450	2400	5250	3550	*5750	*5750		
		-3.0 m	kg	2350	1600	2400	1650	3400	2300	5150	3450	*8500	6200	*5100	*5100
		-3.0 m	kg	2700	1900			3400	2300	5150	3450	10100	6300		
		-4.5 m	kg	*4150	3000					*4800	3600				
 <p>Front or rear blade</p>	2250 mm	7.5 m	kg	*3350	*3350					*5150	*5200				
		6.0 m	kg	*3000	2850			*5000	3450	*5600	5450				
		4.5 m	kg	*2900	2350	*2900	2350	*6050	3350	*7250	5200	*8150	*8150		
		3.0 m	kg	*2950	2100	*5000	2250	*6550	3150	*8600	4800				
		1.5 m	kg	*3100	2000	5450	2200	*6950	3000	*9550	4400				
		0.0 m	kg	*3450	2050	*5300	2150	*7000	2850	*9450	4200				
		-1.5 m	kg	*4150	2250			*6400	2850	*8600	4200	*9100	7650		
		-3.0 m	kg	*4150	2700			*4700	2850	*6700	4200	*8500	7800		
		-4.5 m	kg												
	2600 mm	7.5 m	kg	*2750	*2750										
		4.5 m	kg	*2550	*2550			*4500	3450						
		3.0 m	kg	*2450	2150	*3600	2350	*5550	3350	*6050	5250				
		1.5 m	kg	*2550	1950	*4950	2250	*6350	3150	*8250	4800				
		0.0 m	kg	*2700	1850	5400	2150	*6800	3000	*9300	4400				
		-1.5 m	kg	*3050	1900	*5350	2100	*6950	2850	*9550	4200	*5600	*5600		
		-3.0 m	kg	*3600	2050	*4150	2100	*6500	2800	*8750	4100	*8950	7500		
		-3.0 m	kg	*4250	2450			*5200	2800	*7150	4150	*9450	7650		
		-4.5 m	kg												
	2900 mm	7.5 m	kg	*2350	*2350			*3000	*3000						
		4.5 m	kg	*2150	*2200			*4100	3450						
		3.0 m	kg	*2100	2000	*3700	2300	*4900	3300	*5050	*5050				
		1.5 m	kg	*2150	1800	*4700	2250	*6100	3150	*7800	4850	*12050	9000		
		0.0 m	kg	*2300	1700	*5350	2100	*6650	2950	*9100	4450				
		-1.5 m	kg	*2600	1750	5250	2050	*6850	2800	*9450	4150	*5750	*5750		
		-3.0 m	kg	*3050	1900	*4850	2000	*6550	2700	*8950	4050	*8500	7400	*5100	*5100
		-3.0 m	kg	*4050	2250			*5500	2700	*7550	4050	*10250	7550		
		-4.5 m	kg	*4150	3550					*4800	4200				
 <p>Rear outrigger</p>	2250 mm	7.5 m	kg	*3350	*3350					*5150	*5150				
		6.0 m	kg	*3000	*3000			*5000	4150	*5600	*5600				
		4.5 m	kg	*2900	2850	*2900	2850	*6050	4050	*7250	6300	*8150	*8150		
		3.0 m	kg	*2950	2550	*5000	2800	*6550	3900	*8600	5850				
		1.5 m	kg	*3100	2450	5100	2700	6900	3700	*9550	5450				
		0.0 m	kg	*3450	2500	5050	2650	*7000	3550	*9450	5250				
		-1.5 m	kg	*4150	2750			*6400	3500	*8600	5200	*9100	*9100		
		-3.0 m	kg	*4150	3350			*4700	3550	*6700	5250	*8500	*8500		
		-4.5 m	kg												
	2600 mm	7.5 m	kg	*2750	*2750										
		4.5 m	kg	*2550	*2550			*4500	4200						
		3.0 m	kg	*2450	*2500	*3600	2850	*5550	4050	*6050	*6000				
		1.5 m	kg	*2550	2400	*4950	2750	*6350	3900	*8250	5900				
		0.0 m	kg	*2700	2300	5100	2700	*6800	3650	*9300	5500				
		-1.5 m	kg	*3050	2350	4950	2600	*6950	3500	*9550	5250	*5600	*5600		
		-3.0 m	kg	*3600	2550	*4150	2550	*6500	3450	*8750	5100	*8950	*8950		
		-3.0 m	kg	*4250	3000			*5200	3450	*7150	5150	*9450	*9450		
		-4.5 m	kg												
	2900 mm	7.5 m	kg	*2350	*2350			*3000	*3000						
		4.5 m	kg	*2150	*2150			*4100	*4100						
		3.0 m	kg	*2100	*2100	*3700	2800	*4900	4050	*5050	*5050				
		1.5 m	kg	*2150	*2150	*4700	2700	*6100	3850	*7800	5950	*12050	11300		
		0.0 m	kg	*2300	2150	5000	2600	*6650	3600	*9100	5500				
		-1.5 m	kg	*2600	2150	4950	2550	6850	3450	*9450	5200	*5750	*5750		
		-3.0 m	kg	*3050	2350	4850	2500	*6550	3400	*8950	5100	*8500	*8500	*5100	*5100
		-3.0 m	kg	*4050	2750			*5500	3400	*7550	5100	*10250	9750		
		-4.5 m	kg	*4150	*4150					*4800	*4800				

Arm length	A	⊗		7.5 m		6.0 m		4.5 m		3.0 m		1.5 m		
		⊗	⊗	⊗	⊗	⊗	⊗	⊗	⊗	⊗	⊗	⊗	⊗	
 <p>Outrigger + blade</p>	2250 mm	7.5 m kg	*3350	*3350					*5150	*5150				
		6.0 m kg	*3000	*3000			*5000	*5000	*5600	*5600				
		4.5 m kg	*2900	*2900	*2900	*2900	*6050	5050	*7250	*7250	*8150	*8150		
		3.0 m kg	*2950	*2950	*5000	3450	*6550	4850	*8600	7500				
		1.5 m kg	*3100	3100	*5500	3400	*6950	4650	*9550	7050				
		0.0 m kg	*3450	3150	*5300	3300	*7000	4500	*9450	6850				
		-1.5 m kg	*4150	3450			*6400	4500	*8600	6800	*9100	*9100		
		-3.0 m kg	*4150	*4150			*4700	4500	*6700	*6700	*8500	*8500		
		-4.5 m kg												
	2600 mm	7.5 m kg	*2750	*2750										
		4.5 m kg	*2550	*2550			*4500	*4500						
		3.0 m kg	*2450	*2450	*3600	3550	*5550	5050	*6050	*6050				
		1.5 m kg	*2550	*2550	*4950	3450	*6350	4850	*8250	7550				
		0.0 m kg	*2700	*2700	*5450	3350	*6800	4650	*9300	7100				
		-1.5 m kg	*3050	3000	*5350	3300	*6950	4500	*9550	6800	*5600	*5600		
		-3.0 m kg	*3600	3250	*4150	3300	*6500	4400	*8750	6750	*8950	*8950		
		-3.0 m kg	*4250	3900			*5200	4450	*7150	6750	*9450	*9450		
		-4.5 m kg												
	2900 mm	7.5 m kg	*2350	*2350			*3000	*3000						
		4.5 m kg	*2150	*2150			*4100	*4100						
		3.0 m kg	*2100	*2100	*3700	3500	*4900	*4900	*5050	*5050				
		1.5 m kg	*2150	*2150	*4700	3450	*6100	4850	*7800	7650	*12050	*12050		
		0.0 m kg	*2300	*2300	*5350	3300	*6650	4650	*9100	7100				
		-1.5 m kg	*2600	*2600	*5350	3250	*6850	4450	*9450	6800	*5750	*5750		
		-3.0 m kg	*3050	3000	*4850	3200	*6550	4350	*8950	6650	*8500	*8500	*5100	*5100
		-3.0 m kg	*4050	3550			*5500	4350	*7550	6700	*10250	*10250		
		-4.5 m kg	*4150	*4150					*4800	*4800				

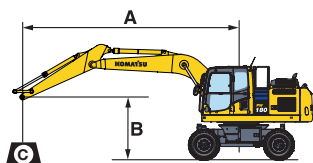

 <p>Outrigger front + rear</p>	2250 mm	7.5 m kg	*3350	*3350					*5150	*5150				
		6.0 m kg	*3000	*3000			*5000	*5000	*5600	*5600				
		4.5 m kg	*2900	*2900	*2900	*2900	*6050	*6050	*7250	*7250	*8150	*8150		
		3.0 m kg	*2950	*2950	*5000	3950	*6550	6000	*8600	*8600				
		1.5 m kg	*3100	*3100	*5500	4150	*6950	5750	*9550	9000				
		0.0 m kg	*3450	*3450	*5300	3800	*7000	5600	*9450	8750				
		-1.5 m kg	*4150	*4150			*6400	5550	*8600	*8600	*9100	*9100		
		-3.0 m kg	*4150	*4150			*4700	*4700	*6700	*6700	*8500	*8500		
		-4.5 m kg												
	2600 mm	7.5 m kg	*2750	*2750										
		4.5 m kg	*2550	*2550			*4500	*4500						
		3.0 m kg	*2450	*2450	*3600	*3600	*5550	*5550	*6050	*6050				
		1.5 m kg	*2550	*2550	*4950	4200	*6350	6000	*8250	*8250				
		0.0 m kg	*2700	*2700	*5450	3850	*6800	5750	*9300	9000				
		-1.5 m kg	*3050	*3050	*5350	4050	*6950	5550	*9550	8700	*5600	*5600		
		-3.0 m kg	*3600	*3600	*4150	4050	*6500	5500	*8750	8600	*8950	*8950		
		-3.0 m kg	*4250	*4250			*5200	*5200	*7150	*7150	*9450	*9450		
		-4.5 m kg												
	2900 mm	7.5 m kg	*2350	*2350			*3000	*3000						
		4.5 m kg	*2150	*2150			*4100	*4100						
		3.0 m kg	*2100	*2100	*3700	*3700	*4900	*4900	*5050	*5050				
		1.5 m kg	*2150	*2150	*4700	4200	*6100	5950	*7800	*7800	*12050	*12050		
		0.0 m kg	*2300	*2300	*5350	4050	*6650	5700	*9100	9050				
		-1.5 m kg	*2600	*2600	*5350	4000	*6850	5550	*9450	8700	*5750	*5750		
		-3.0 m kg	*3050	*3050	*4850	3950	*6550	5450	*8950	8550	*8500	*8500	*5100	*5100
		-3.0 m kg	*4050	*4050			*5500	5450	*7550	*7550	*10250	*10250		
		-4.5 m kg	*4150	*4150					*4800	*4800				



- A - Reach from swing center
- B - Bucket hook height
- C - Lifting capacities, including bucket linkage (120 kg) and bucket cylinder (109 kg)

When removing linkage or cylinder, lifting capacities can be increased by their respective weights.

* Load is limited by hydraulic capacity rather than tipping. Ratings are based on ISO standard 10567. Rated loads do not exceed 87% of hydraulic lift capacity or 75% of tipping load.

-  - Rating over front
-  - Rating over side
-  - Rating at maximum reach

Lifting capacity / two-piece boom / undercarriage width 2.55 m

Arm length	A B	⊗		7.5 m		6.0 m		4.5 m		3.0 m		1.5 m			
		⊗	⊗	⊗	⊗	⊗	⊗	⊗	⊗	⊗	⊗	⊗	⊗		
 <p>Without stabilizer</p>	2250 mm	7.5 m	kg	*3650	3400					*5450	4800				
		6.0 m	kg	*3150	2400			4150	3000	*5400	4800				
		4.5 m	kg	2800	2000	2850	2050	4050	2950	6350	4550	*6350	*6350		
		3.0 m	kg	2550	1800	2800	1950	3900	2800	6000	4200				
		1.5 m	kg	2400	1750	2700	1950	3650	2600	5600	3800				
		0.0 m	kg	2550	1800	2700	1850	3600	2550	5400	3650				
		- 1.5 m	kg	2750	1950			3600	2450	5400	3600	*8250	6600		
		- 3.0 m	kg												
		- 4.5 m	kg												
	2600 mm	7.5 m	kg	*3000	*3000										
		6.0 m	kg	*2700	2200			4200	3000						
		4.5 m	kg	*2550	1850	2850	2050	4050	2950	*5400	4600				
		3.0 m	kg	2400	1650	2750	1950	3900	2800	6000	4200				
		1.5 m	kg	2300	1600	2700	1900	3750	2550	5600	3850				
		0.0 m	kg	2350	1650	2650	1800	3600	2450	5400	3600				
		- 1.5 m	kg	2550	1800	2600	1800	3350	2400	5300	3550	*8150	6450		
		- 3.0 m	kg	3250	2250			3550	2450	5350	3600				
		- 4.5 m	kg												
	2900 mm	7.5 m	kg	*2550	*2550			*3450	3000						
		6.0 m	kg	*2300	2000			4150	3000						
		4.5 m	kg	*2200	1650	2800	1950	4050	2900	*4550	*4550				
		3.0 m	kg	2200	1500	2700	1950	3900	2750	6000	4200				
		1.5 m	kg	2100	1450	2650	1800	3700	2550	5600	3850				
		0.0 m	kg	2150	1500	2550	1750	3550	2400	5350	3600	*4900	*4900		
		- 1.5 m	kg	2350	1650	2500	1750	3450	2350	5250	3500	*7700	6350		
		- 3.0 m	kg	2850	1950			3450	2350	5250	3550				
		- 4.5 m	kg												
 <p>Front or rear blade</p>	2250 mm	7.5 m	kg	*3650	*3650					*5450	5450				
		6.0 m	kg	*3150	2800			*5200	3450	*5400	*5350				
		4.5 m	kg	*3000	2300	*3350	2350	*5600	3350	*6500	5200	*6350	*6350		
		3.0 m	kg	*3000	2100	*4750	2300	*5950	3200	*8250	4800				
		1.5 m	kg	*3050	2000	*4950	2250	*6400	3050	*9550	4500				
		0.0 m	kg	*3350	2100	*5200	2200	*7000	2950	*9550	4300				
		- 1.5 m	kg	*3850	2250			*6400	2900	*8700	4250	*8250	7850		
		- 3.0 m	kg												
		- 4.5 m	kg												
	2600 mm	7.5 m	kg	*3000	*3000										
		6.0 m	kg	*2700	2550			*4650	3450						
		4.5 m	kg	*2550	2150	*3950	2350	*5400	3350	*5400	5250				
		3.0 m	kg	*2550	1950	*4600	2250	*5700	3200	*7800	4850				
		1.5 m	kg	*2650	1900	*4800	2200	*6200	3000	*9300	4500				
		0.0 m	kg	*2900	1950	*5050	2150	*6750	2900	*9550	4250				
		- 1.5 m	kg	*3350	2100	*4600	2100	*6600	2850	*8950	4200	*8150	7700		
		- 3.0 m	kg	*4700	2700			*5250	2850	*7300	4200				
		- 4.5 m	kg												
	2900 mm	7.5 m	kg	*2550	*2550			*3450	3450						
		6.0 m	kg	*2300	*2300			*4150	3450						
		4.5 m	kg	*2200	1950	*3900	2300	*4700	3300	*4550	*4550				
		3.0 m	kg	*2200	1800	*4400	2250	*5550	3150	*7550	4850				
		1.5 m	kg	*2300	1750	*4650	2150	*6050	3000	*8850	4500				
		0.0 m	kg	*2450	1750	*4900	2100	*6600	2850	*9550	4200	*4900	*4900		
		- 1.5 m	kg	*2850	1900	*4900	2050	*6650	2800	*9050	4150	*7700	7650		
		- 3.0 m	kg	*4150	2300			*5550	2800	*7650	4150				
		- 4.5 m	kg												
 <p>Rear outrigger</p>	2250 mm	7.5 m	kg	*3650	*3600					*5450	*5450				
		6.0 m	kg	*3150	*3150			*5200	4150	*5400	*5350				
		4.5 m	kg	*3000	2850	*3350	2850	*5600	4050	*6500	6300	*6350	*6350		
		3.0 m	kg	*3000	2550	*4750	2800	*5950	3900	*8250	5900				
		1.5 m	kg	*3050	2500	*4950	2700	*6400	3750	*9550	5550				
		0.0 m	kg	*3350	2550	5100	2700	*7000	3600	*9550	5350				
		- 1.5 m	kg	*3850	2800			*6400	3600	*8700	5300	*8250	*8250		
		- 3.0 m	kg												
		- 4.5 m	kg												
	2600 mm	7.5 m	kg	*3000	*3000										
		6.0 m	kg	*2700	*2650			*4650	4150						
		4.5 m	kg	*2550	*2550	*3950	2850	*5400	4050	*5400	*5400				
		3.0 m	kg	*2550	2400	*4600	2800	*5700	3900	*7800	5950				
		1.5 m	kg	*2650	2300	*4800	2700	*6200	3700	*9300	5550				
		0.0 m	kg	*2900	2400	*5050	2650	*6750	3600	*9550	5300				
		- 1.5 m	kg	*3350	2550	*4600	2650	*6600	3500	*8950	5250	*8150	*8150		
		- 3.0 m	kg	*4700	3300			*5250	3550	*7300	5300				
		- 4.5 m	kg												
	2900 mm	7.5 m	kg	*2550	*2550			*3450	*3450						
		6.0 m	kg	*2300	*2300			*4150	4150						
		4.5 m	kg	*2200	*2200	*3900	2850	*4700	4050	*4550	*4550				
		3.0 m	kg	*2200	*2200	*4400	2750	*5550	3850	*7550	5950				
		1.5 m	kg	*2300	2150	*4650	2650	*6050	3650	*8850	5550				
		0.0 m	kg	*2450	2200	*4900	2550	*6600	3550	*9550	5250	*4900	*4900		
		- 1.5 m	kg	*2850	2400	*4900	2550	*6650	3450	*9050	5200	*7700	*7700		
		- 3.0 m	kg	*4150	2850			*5550	3450	*7650	5250				
		- 4.5 m	kg												

Arm length	A B	⊗		7.5 m		6.0 m		4.5 m		3.0 m		1.5 m		
		🔧	🔗	🔧	🔗	🔧	🔗	🔧	🔗	🔧	🔗	🔧	🔗	
 <p>Outrigger + blade</p>	2250 mm	7.5 m	kg	*3650	*3650			*5450	*5450					
		6.0 m	kg	*3150	*3150			*5200	5150	*5400	*5400			
		4.5 m	kg	*3000	*3000	*3350	*3350	*5600	5050	*6500	*6500	*6350	*6350	
		3.0 m	kg	*3000	*3000	*4750	3500	*5950	4900	*8250	7550			
		1.5 m	kg	*3050	*3050	*4950	3450	*6400	4700	*9550	7150			
		0.0 m	kg	*3350	3200	*5200	3400	*7000	4600	*9550	6950			
		-1.5 m	kg	*3850	3550			*6400	4550	*8700	6900	*8250	*8250	
		-3.0 m	kg											
		-4.5 m	kg											
	2600 mm	7.5 m	kg	*3000	*3000									
		6.0 m	kg	*2700	*2700			*4650	*4650					
		4.5 m	kg	*2550	*2550	*3950	3600	*5400	5100	*5400	*5400			
		3.0 m	kg	*2550	*2550	*4600	3500	*5700	4900	*7800	7650			
		1.5 m	kg	*2650	*2650	*4800	3400	*6200	4700	*9300	7200			
		0.0 m	kg	*2900	*2900	*5050	3350	*6750	4550	*9550	6900			
		-1.5 m	kg	*3350	3300	*4600	3300	*6600	4500	*8950	6850	*8150	*8150	
		-3.0 m	kg	*4700	4200			*5250	4550	*7300	6900			
		-4.5 m	kg											
	2900 mm	7.5 m	kg	*2550	*2550			*3450	*3450					
		6.0 m	kg	*2300	*2300			*4150	*4150					
		4.5 m	kg	*2200	*2200	*3900	3550	*4700	*4700	*4550	*4550			
		3.0 m	kg	*2200	*2200	*4400	3450	*5550	4850	*7550	*7550			
		1.5 m	kg	*2300	*2300	*4650	3350	*6050	4650	*8850	7200			
		0.0 m	kg	*2450	*2450	*4900	3300	*6600	4500	*9550	6900	*4900	*4900	
-1.5 m		kg	*2850	*2850	*4900	3250	*6650	4450	*9050	6750	*7700	*7700		
-3.0 m		kg	*4150	3650			*5550	4450	*7650	6800				
-4.5 m		kg												

 <p>Outrigger front + rear</p>	2250 mm	7.5 m	kg	*3650	*3650			*5450	*5450					
		6.0 m	kg	*3150	*3150			*5200	*5200	*5400	*5400			
		4.5 m	kg	*3000	*3000	*3350	*3350	*5600	*5600	*6500	*6500	*6350	*6350	
		3.0 m	kg	*3000	*3000	*4750	4300	*5950	*5950	*8250	*8250			
		1.5 m	kg	*3050	*3050	*4950	4200	*6400	5850	*9550	9050			
		0.0 m	kg	*3350	*3350	*5200	4150	*7000	5700	*9550	8900			
		-1.5 m	kg	*3850	*3850			*6400	5650	*8700	*8700	*8250	*8250	
		-3.0 m	kg											
		-4.5 m	kg											
	2600 mm	7.5 m	kg	*3000	*3000									
		6.0 m	kg	*2700	*2700			*4650	*4650					
		4.5 m	kg	*2550	*2550	*3950	*3950	*5400	*5400	*5400	*5400			
		3.0 m	kg	*2550	*2550	*4600	4250	*5700	*5700	*7800	*7800			
		1.5 m	kg	*2650	*2650	*4800	4200	*6200	5800	*9300	9150			
		0.0 m	kg	*2900	*2900	*5050	3850	*6750	5650	*9550	8850			
		-1.5 m	kg	*3350	*3350	*4600	4100	*6600	5600	*8950	8750	*8150	*8150	
		-3.0 m	kg	*4700	*4700			*5250	*5250	*7300	*7300			
		-4.5 m	kg											
	2900 mm	7.5 m	kg	*2550	*2550			*3450	*3450					
		6.0 m	kg	*2300	*2300			*4150	*4150					
		4.5 m	kg	*2200	*2200	*3900	*3900	*4700	*4700	*4550	*4550			
		3.0 m	kg	*2200	*2200	*4400	4200	*5550	*5550	*7550	*7550			
		1.5 m	kg	*2300	*2300	*4650	4100	*6050	5750	*8850	*8850			
		0.0 m	kg	*2450	*2450	*4900	4050	*6600	5600	*9550	8850	*4900	*4900	
-1.5 m		kg	*2850	*2850	*4900	3750	*6650	5550	*9050	8700	*7700	*7700		
-3.0 m		kg	*4150	*4150			*5550	*5550	*7650	*7650				
-4.5 m		kg												

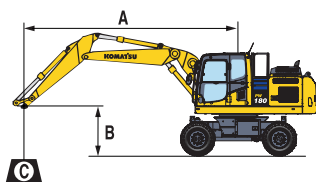

- A – Reach from swing center
- B – Bucket hook height
- C – Lifting capacities, including bucket linkage (120 kg) and bucket cylinder (109 kg)

When removing linkage or cylinder, lifting capacities can be increased by their respective weights.

* Load is limited by hydraulic capacity rather than tipping. Ratings are based on ISO standard 10567. Rated loads do not exceed 87% of hydraulic lift capacity or 75% of tipping load.

- 🔧 – Rating over front
- 🔗 – Rating over side
- ⊗ – Rating at maximum reach

Lifting capacity / mono boom / undercarriage width 2.75 m

Arm length	A B	⊗		7.5 m		6.0 m		4.5 m		3.0 m		1.5 m			
		⊗	⊗	⊗	⊗	⊗	⊗	⊗	⊗	⊗	⊗	⊗	⊗		
 <p>Without stabilizer</p>	2250 mm	7.5 m	kg	*3350	*3350					*5150	*5150				
		6.0 m	kg	*3000	2700			4150	3300	*5600	5300				
		4.5 m	kg	2850	2250	2850	2250	4050	3250	6350	5050	*8150	*8150		
		3.0 m	kg	2550	2000	2750	2200	3900	3100	5950	4650				
		1.5 m	kg	2400	1950	2700	2100	3700	2850	5550	4300				
		0.0 m	kg	2450	1950	2600	2050	3550	2800	5300	4050				
		- 1.5 m	kg	2750	2150			3500	2700	5250	4050	*9100	7450		
		- 3.0 m	kg	3350	2600			3550	2800	5300	4100	*8500	7650		
		- 4.5 m	kg												
	2600 mm	7.5 m	kg	*2750	*2750										
		6.0 m	kg	*2550	2550			4200	3350						
		4.5 m	kg	*2450	2100	2850	2250	4050	3300	*6050	5100				
		3.0 m	kg	2400	1900	2750	2200	3900	3100	6000	4700				
		1.5 m	kg	2250	1800	2650	2100	3650	2850	5550	4300				
		0.0 m	kg	2250	1800	2550	2000	3500	2750	5250	4050	*5600	*5600		
		- 1.5 m	kg	2400	1950	2550	2000	3450	2650	5200	3950	*8950	7300		
		- 3.0 m	kg	3000	2400			3450	2700	5250	4000	*9450	7400		
		- 4.5 m	kg												
	2900 mm	7.5 m	kg	*2350	*2350			*3000	*3000						
		6.0 m	kg	*2150	*2150			*4100	3300						
		4.5 m	kg	*2100	1950	2800	2250	4050	3250	*5050	*5050				
		3.0 m	kg	*2150	1750	2700	2100	3850	3050	6000	4700	11750	8750		
		1.5 m	kg	2100	1650	2600	2050	3650	2850	5550	4300				
		0.0 m	kg	2150	1650	2500	1950	3450	2700	5250	4050	*5750	*5750		
		- 1.5 m	kg	2350	1800	2400	1950	3400	2600	5150	3900	*8500	7200	*5100	*5100
		- 3.0 m	kg	2700	2100			3400	2600	5150	3900	10100	7350		
		- 4.5 m	kg	*4150	3450					*4800	4050				
 <p>Front or rear blade</p>	2250 mm	7.5 m	kg	*3350	*3350					*5150	*5150				
		6.0 m	kg	*3000	*3000			*5000	3800	*5600	*5600				
		4.5 m	kg	*2900	2550	*2900	2550	*6050	3700	*7250	5750	*8150	*8150		
		3.0 m	kg	*2950	2300	*5000	2550	*6550	3500	*8600	5350				
		1.5 m	kg	*3100	2250	5450	2450	*6950	3350	*9550	4950				
		0.0 m	kg	*3450	2250	*5300	2400	*7000	3200	*9450	4750				
		- 1.5 m	kg	*4150	2500			*6400	3150	*8600	4700	*9100	8750		
		- 3.0 m	kg	*4150	3000			*4700	3200	*6700	4750	*8500	*8500		
		- 4.5 m	kg												
	2600 mm	7.5 m	kg	*2750	*2750										
		6.0 m	kg	*2550	*2550			*4500	3800						
		4.5 m	kg	*2450	2400	*3600	2550	*5550	3700	*6050	5800				
		3.0 m	kg	*2550	2200	*4950	2500	*6350	3500	*8250	5400				
		1.5 m	kg	*2700	2100	5350	2400	*6800	3300	*9300	4950				
		0.0 m	kg	*3050	2100	*5350	2350	*6950	3150	*9550	4700	*5600	*5600		
		- 1.5 m	kg	*3600	2300	*4150	2300	*6500	3100	*8750	4650	*8950	8600		
		- 3.0 m	kg	*4250	2750			*5200	3150	*7150	4650	*9450	8750		
		- 4.5 m	kg												
	2900 mm	7.5 m	kg	*2350	*2350			*3000	*3000						
		6.0 m	kg	*2150	*2150			*4100	3800						
		4.5 m	kg	*2100	*2100	*3700	2550	*4900	3700	*5050	*5050				
		3.0 m	kg	*2150	2000	*4700	2450	*6100	3500	*7800	5400	*12050	10200		
		1.5 m	kg	*2300	1950	*5350	2400	*6650	3300	*9100	4950				
		0.0 m	kg	*2600	1950	5250	2250	*6850	3150	*9450	4650	*5750	*5750		
		- 1.5 m	kg	*3050	2100	*4850	2250	*6550	3050	*8950	4550	*8500	*8500	*5100	*5100
		- 3.0 m	kg	*4050	2500			*5500	3050	*7550	4600	*10250	8700		
		- 4.5 m	kg	*4150	4000					*4800	4700				
 <p>Rear outrigger</p>	2250 mm	7.5 m	kg	*3350	*3350					*5150	*5150				
		6.0 m	kg	*3000	*3000			*5000	4650	*5600	*5600				
		4.5 m	kg	*2900	*2900	*2900	*2900	*6050	4500	*7250	7100	*8150	*8150		
		3.0 m	kg	*2950	2850	*5000	3150	*6550	4350	*8600	6650				
		1.5 m	kg	*3100	2800	5100	3050	*6950	4200	*9550	6250				
		0.0 m	kg	*3450	2850	4800	3000	*7000	4050	*9450	6000				
		- 1.5 m	kg	*4150	3100			*6400	4000	*8600	6000	*9100	*9100		
		- 3.0 m	kg	*4150	3750			*4700	4050	*6700	6050	*8500	*8500		
		- 4.5 m	kg												
	2600 mm	7.5 m	kg	*2750	*2750										
		6.0 m	kg	*2550	*2550			*4500	*4550						
		4.5 m	kg	*2450	*2450	*3600	3150	*5550	4550	*6050	*6000				
		3.0 m	kg	*2550	*2550	*4950	3100	*6350	4350	*8250	6700				
		1.5 m	kg	*2700	2600	5100	3000	*6800	4150	*9300	6250				
		0.0 m	kg	*3050	2650	4950	2950	*6950	4000	*9550	6000	*5600	*5600		
		- 1.5 m	kg	*3600	2850	*4150	2900	*6500	3900	*8750	5900	*8950	*8950		
		- 3.0 m	kg	*4250	3450			*5200	3950	*7150	5950	*9450	*9450		
		- 4.5 m	kg												
	2900 mm	7.5 m	kg	*2350	*2350			*3000	*3000						
		6.0 m	kg	*2150	*2150			*4100	*4100						
		4.5 m	kg	*2100	*2100	*3700	3150	*4900	4500	*5050	*5050				
		3.0 m	kg	*2150	*2150	*4700	3050	*6100	4350	*7800	6750	*12050	*12050		
		1.5 m	kg	*2300	*2300	5050	3000	*6650	4100	*9100	6300				
		0.0 m	kg	*2600	2450	4950	2850	*6850	3950	*9450	6000	*5750	*5750		
		- 1.5 m	kg	*3050	2700	*4850	2850	*6550	3900	*8950	5850	*8500	*8500	*5100	*5100
		- 3.0 m	kg	*4050	3150			*5500	3900	*7550	5850	*10250	*10250		
		- 4.5 m	kg	*4150	*4150					*4800	*4800				

Arm length	A	⊗		7.5 m		6.0 m		4.5 m		3.0 m		1.5 m		
		⊗	⊗	⊗	⊗	⊗	⊗	⊗	⊗	⊗	⊗	⊗	⊗	
	B	⊗	⊗	⊗	⊗	⊗	⊗	⊗	⊗	⊗	⊗	⊗	⊗	
 <p>Outrigger + blade</p>	2250 mm	7.5 m kg	*3350	*3350					*5150	*5150				
		6.0 m kg	*3000	*3000			*5000	*5000	*5600	*5600				
		4.5 m kg	*2900	*2900	*2900	*2900	*6050	5600	*7250	*7250	*8150	*8150		
		3.0 m kg	*2950	*2950	*5000	3900	*6550	5400	*8600	8450				
		1.5 m kg	*3100	*3100	*5500	3800	*6950	5250	*9550	8100				
		0.0 m kg	*3450	*3450	5250	3750	*7000	5100	*9450	7850				
		-1.5 m kg	*4150	3900			*6400	5050	*8600	7800	*9100	*9100		
		-3.0 m kg	*4150	*4150			*4700	*4700	*6700	*6700	*8500	*8500		
		-4.5 m kg												
	2600 mm	7.5 m kg	*2750	*2750										
		6.0 m kg	*2550	*2550			*4500	*4500						
		4.5 m kg	*2450	*2450	*3600	*3600	*5550	*5550	*6050	*6050				
		3.0 m kg	*2550	*2550	*4950	3900	*6350	5400	*8250	*8250				
		1.5 m kg	*2700	*2700	*5450	3750	*6800	5250	*9300	8100				
		0.0 m kg	*3050	*3050	5250	3700	*6950	5050	*9550	7800	*5600	*5600		
		-1.5 m kg	*3600	*3600	*4150	3650	*6500	4950	*8750	7700	*8950	*8950		
		-3.0 m kg	*4250	*4200			*5200	5000	*7150	*7150	*9450	*9450		
		-4.5 m kg												
	2900 mm	7.5 m kg	*2350	*2350			*3000	*3000						
		6.0 m kg	*2150	*2150			*4100	*4100						
		4.5 m kg	*2100	*2100	*3700	*3700	*4900	*4900	*5050	*5050				
		3.0 m kg	*2150	*2150	*4700	3800	*6100	5400	*7800	*7800	*12050	*12050		
		1.5 m kg	*2300	*2300	*5350	3750	*6650	5200	*9100	8100				
		0.0 m kg	*2600	*2600	5250	3600	*6850	5000	*9450	7800	*5750	*5750		
		-1.5 m kg	*3050	*3050	*4850	3600	*6550	4950	*8950	7650	*8500	*8500	*5100	*5100
		-3.0 m kg	*4050	3950			*5500	4950	*7550	*7550	*10250	*10250		
		-4.5 m kg	*4150	*4150					*4800	*4800				

 <p>Outrigger front + rear</p>	2250 mm	7.5 m kg	*3350	*3350					*5150	*5150				
		6.0 m kg	*3000	*3000			*5000	*5000	*5600	*5600				
		4.5 m kg	*2900	*2900	*2900	*2900	*6050	*6050	*7250	*7250	*8150	*8150		
		3.0 m kg	*2950	*2950	*5000	4800	*6550	*6550	*8600	*8600				
		1.5 m kg	*3100	*3100	*5500	4700	*6950	6600	*9550	*9550				
		0.0 m kg	*3450	*3450	*5300	4650	*7000	6450	*9450	*9450				
		-1.5 m kg	*4150	*4150			*6400	*6400	*8600	*8600	*9100	*9100		
		-3.0 m kg	*4150	*4150			*4700	*4700	*6700	*6700	*8500	*8500		
		-4.5 m kg												
	2600 mm	7.5 m kg	*2750	*2750										
		6.0 m kg	*2550	*2550			*4500	*4500						
		4.5 m kg	*2450	*2450	*3600	*3600	*5550	*5550	*6050	*6050				
		3.0 m kg	*2550	*2550	*4950	4800	*6350	*6350	*8250	*8250				
		1.5 m kg	*2700	*2700	*5450	4700	*6800	6600	*9300	*9300				
		0.0 m kg	*3050	*3050	*5350	4600	*6950	6400	*9550	*9550	*5600	*5600		
		-1.5 m kg	*3600	*3600	*4150	*4150	*6500	6300	*8750	*8750	*8950	*8950		
		-3.0 m kg	*4250	*4250			*5200	*5200	*7150	*7150	*9450	*9450		
		-4.5 m kg												
	2900 mm	7.5 m kg	*2350	*2350			*3000	*3000						
		6.0 m kg	*2150	*2150			*4100	*4100						
		4.5 m kg	*2100	*2100	*3700	*3700	*4900	*4900	*5050	*5050				
		3.0 m kg	*2150	*2150	*4700	*4700	*6100	*6100	*7800	*7800	*12050	*12050		
		1.5 m kg	*2300	*2300	*5350	4650	*6650	6550	*9100	*9100				
		0.0 m kg	*2600	*2600	*5350	4550	*6850	6350	*9450	*9450	*5750	*5750		
		-1.5 m kg	*3050	*3050	*4850	4500	*6550	6300	*8950	*8950	*8500	*8500	*5100	*5100
		-3.0 m kg	*4050	*4050			*5500	*5500	*7550	*7550	*10250	*10250		
		-4.5 m kg	*4150	*4150					*4800	*4800				

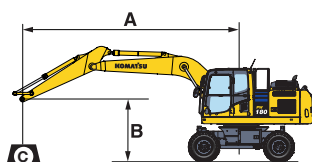

- A – Reach from swing center
- B – Bucket hook height
- C – Lifting capacities, including bucket linkage (120 kg) and bucket cylinder (109 kg)

When removing linkage or cylinder, lifting capacities can be increased by their respective weights.

* Load is limited by hydraulic capacity rather than tipping. Ratings are based on ISO standard 10567. Rated loads do not exceed 87% of hydraulic lift capacity or 75% of tipping load.

- ⊗ – Rating over front
- ⊗ – Rating over side
- ⊗ – Rating at maximum reach

Lifting capacity / two-piece boom / undercarriage width 2.75 m

Arm length	A B	⊗		7.5 m		6.0 m		4.5 m		3.0 m		1.5 m			
		⊗	⊗	⊗	⊗	⊗	⊗	⊗	⊗	⊗	⊗	⊗	⊗		
 <p>Without stabilizer</p>	2250 mm	7.5 m	kg	*3650	*3650					*5450	5350				
		6.0 m	kg	*3150	2700			4150	3350	*5400	5300				
		4.5 m	kg	2800	2250	2850	2250	4050	3300	6350	5050	*6350	*6350		
		3.0 m	kg	2550	2050	2800	2250	3900	3100	6000	4650				
		1.5 m	kg	2400	1950	2700	2150	3650	2900	5600	4350				
		0.0 m	kg	2550	1950	2700	2100	3600	2850	5400	4200				
		-1.5 m	kg	2750	2200			3600	2800	5400	4100	*8250	7650		
	-3.0 m	kg													
	-4.5 m	kg													
	2600 mm	7.5 m	kg	*3000	*3000										
		4.5 m	kg	*2700	2450			4200	3350						
		3.0 m	kg	*2550	2100	2850	2250	4050	3300	*5400	5100				
		1.5 m	kg	2400	1850	2750	2200	3900	3100	6000	4700				
		0.0 m	kg	2300	1800	2700	2100	3750	2900	5600	4350				
		-1.5 m	kg	2350	1850	2650	2050	3600	2800	5400	4100				
		-3.0 m	kg	2550	2000	2600	2050	3350	2750	5300	4050	*8150	7450		
	-3.0 m	kg	3250	2550			3550	2800	5350	4100					
	-4.5 m	kg													
	2900 mm	7.5 m	kg	*2550	*2550			*3450	3300						
		4.5 m	kg	*2300	2250			4150	3350						
		3.0 m	kg	*2200	1900	2800		4050	3250	*4550	*4550				
		1.5 m	kg	2200		2700	2150	3900	3050	6000	4750				
		0.0 m	kg	2100	1650	2650	2100	3700		5600					
		-1.5 m	kg	2150	1650	2550		3550	2750	5350	4100	*4900	*4900		
		-3.0 m	kg	2350	1800	2500	1950	3450		5250		*7700	7400		
	-3.0 m	kg	2850				3450		5250						
	-4.5 m	kg													
 <p>Front or rear blade</p>	2250 mm	7.5 m	kg	*3650	*3650					*5450	*5450				
		6.0 m	kg	*3150	3050			*5200	3800	*5400	*5350				
		4.5 m	kg	*3000	2550	*3350	2600	*5600	3700	*6500	5750	*6350	*6350		
		3.0 m	kg	*3000	2350	*4750	2550	*5950	3550	*8250	5350				
		1.5 m	kg	*3050	2250	*4950	2500	*6400	3400	*9550	5000				
		0.0 m	kg	*3350	2300	*5200	2400	*7000	3300	*9550	4800				
		-1.5 m	kg	*3850	2550			*6400	3250	*8700	4800	*8250	*8250		
	-3.0 m	kg													
	-4.5 m	kg													
	2600 mm	7.5 m	kg	*3000	*3000										
		4.5 m	kg	*2700	*2650			*4650	3800						
		3.0 m	kg	*2550	2400	*3950	2600	*5400	3750	*5400	*5400				
		1.5 m	kg	*2550	2150	*4600	2550	*5700	3550	*7800	5400				
		0.0 m	kg	*2650	2100	*4800	2450	*6200	3350	*9300	5000				
		-1.5 m	kg	*2900	2150	*5050	2400	*6750	3250	*9550	4800				
		-3.0 m	kg	*3350	2350	*4600	2400	*6600	3150	*8950	4700	*8150	*8150		
	-3.0 m	kg	*4700	3000			*5250	3200	*7300	4800					
	-4.5 m	kg													
	2900 mm	7.5 m	kg	*2550	*2550			*3450	*3450						
		4.5 m	kg	*2300	*2300			*4150	3800						
		3.0 m	kg	*2200	2200	*3900	2550	*4700	3700	*4550	*4550				
		1.5 m	kg	*2200	2000	*4400	2500	*5550	3500	*7550	5400				
		0.0 m	kg	*2300	1950	*4650	2400	*6050	3300	*8850	5000				
		-1.5 m	kg	*2450	1950	*4900	2350	*6600	3150	*9550	4750	*4900	*4900		
		-3.0 m	kg	*2850	2150	*4900	2300	*6650	3150	*9050	4650	*7700	*7700		
	-3.0 m	kg	*4150	2550			*5550	3150	*7650	4700					
	-4.5 m	kg													
 <p>Rear outrigger</p>	2250 mm	7.5 m	kg	*3650	3500					*5450	4950				
		6.0 m	kg	*3150	2400			*5200	3000	*5400	4750				
		4.5 m	kg	*3000	2150	*3350	2050	*5600	3100	*6500	4450	*6350	*6350		
		3.0 m	kg	*3000	1950	*4750	2100	*5950	2900	*8250	4050				
		1.5 m	kg	*3050	1850	*4950	2050	*6400	2700	*9550	3850				
		0.0 m	kg	*3350	1900	4950	1950	*7000	2650	*9550	3850				
		-1.5 m	kg	*3850	1950			*6400	2650	*8700	3600	*8250	6350		
	-3.0 m	kg													
	-4.5 m	kg													
	2600 mm	7.5 m	kg	*3000	*3000										
		4.5 m	kg	*2700	2250			*4650	3150						
		3.0 m	kg	*2550	1900	*3950	2050	*5400	3000	*5400	4500				
		1.5 m	kg	*2550	1650	*4600	2100	*5700	2750	*7800	4050				
		0.0 m	kg	*2650	1700	*4800	2050	*6200	2650	*9300	3900				
		-1.5 m	kg	*2900	1650	*5050	1800	*6750	2550	*9550	3750				
		-3.0 m	kg	*3350	1850	*4600	1950	*6600	2450	*8950	3700	*8150	6450		
	-3.0 m	kg	*4700	2250			*5250	2500	*7300	3600					
	-4.5 m	kg													
	2900 mm	7.5 m	kg	*2550	*2550			*3450	3100						
		4.5 m	kg	*2300	2100			*4150	3000						
		3.0 m	kg	*2200	1850	*3900	2100	*4700	2850	*4550	*4550				
		1.5 m	kg	*2200	1550	*4400	2050	*5550	2750	*7550	4200				
		0.0 m	kg	*2300	1600	*4650	1950	*6050	2550	*8850	3800				
		-1.5 m	kg	*2450	1650	*4900	1900	*6600	2550	*9550	3550	*4900	*4900		
		-3.0 m	kg	*2850	1700	4900	1850	*6650	2450	*9050	3400	*7700	6300		
	-3.0 m	kg	*4150	2100			*5550	2550	*7650	3500					
	-4.5 m	kg													

Arm length	A	⊗		7.5 m		6.0 m		4.5 m		3.0 m		1.5 m		
		⊗	⊗	⊗	⊗	⊗	⊗	⊗	⊗	⊗	⊗	⊗	⊗	
 <p>Outrigger + blade</p>	2250 mm	7.5 m kg	*3650	*3650					*5450	*5450				
		6.0 m kg	*3150	*3150			*5200	*5200	*5400	*5400				
		4.5 m kg	*3000	*3000	*3350	*3350	*5600	*5600	*6500	*6500	*6350	*6350		
		3.0 m kg	*3000	*3000	*4750	3900	*5950	5450	*8250	*8250				
		1.5 m kg	*3050	*3050	*4950	3850	*6400	5300	*9550	8150				
		0.0 m kg	*3350	*3350	*5200	3800	*7000	5150	*9550	7950				
		-1.5 m kg	*3850	*3850			*6400	5100	*8700	7950	*8250	*8250		
		-3.0 m kg												
		-4.5 m kg												
	2600 mm	7.5 m kg	*3000	*3000										
		4.5 m kg	*2700	*2700			*4650	*4650						
		3.0 m kg	*2550	*2550	*3950	*3950	*5400	*5350	*5400	*5400				
		1.5 m kg	*2550	*2550	*4600	3900	*5700	5450	*7800	*7800				
		0.0 m kg	*2650	*2650	*4800	3800	*6200	5250	*9300	8150				
		-1.5 m kg	*2900	*2900	*5050	3750	*6750	5100	*9550	7950				
		-3.0 m kg	*3350	*3350	*4600	3750	*6600	5100	*8950	7800	*8150	*8150		
		-3.0 m kg	*4700	*4650			*5250	5100	*7300	*7200				
		-4.5 m kg												
	2900 mm	7.5 m kg	*2550	*2550			*3450	*3450						
		4.5 m kg	*2300	*2300			*4150	*4150						
		3.0 m kg	*2200	*2200	*3900	*3900	*4700	*4700	*4550	*4550				
		1.5 m kg	*2200	*2200	*4400	3850	*5550	5450	*7550	*7550				
		0.0 m kg	*2300	*2300	*4650	3750	*6050	5250	*8850	8150				
		-1.5 m kg	*2450	*2450	*4900	3700	*6600	5100	*9550	7850	*4900	*4900		
		-3.0 m kg	*2850	*2850	*4900	3650	*6650	5000	*9050	7800	*7700	*7700		
		-3.0 m kg	*4150	4100			*5550	5050	*7650	*7650				
		-4.5 m kg												

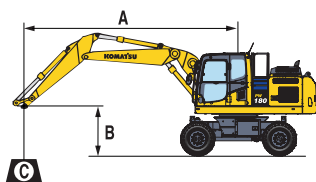

 <p>Outrigger front + rear</p>	2250 mm	7.5 m kg	*3650	*3650					*5450	*5450				
		6.0 m kg	*3150	*3150			*5200	*5200	*5400	*5400				
		4.5 m kg	*3000	*3000	*3350	*3350	*5600	*5600	*6500	*6500	*6350	*6350		
		3.0 m kg	*3000	*3000	*4750	*4750	*5950	*5950	*8250	*8250				
		1.5 m kg	*3050	*3050	*4950	4800	*6400	*6400	*9550	*9550				
		0.0 m kg	*3350	*3350	*5200	4700	*7000	6550	*9550	9550				
		-1.5 m kg	*3850	*3850			*6400	*6400	*8700	*8700	*8250	*8250		
		-3.0 m kg												
		-4.5 m kg												
	2600 mm	7.5 m kg	*3000	*3000										
		4.5 m kg	*2700	*2700			*4650	*4650						
		3.0 m kg	*2550	*2550	*3950	*3950	*5400	*5400	*5400	*5400				
		1.5 m kg	*2550	*2550	*4600	*4600	*5700	*5700	*7800	*7800				
		0.0 m kg	*2650	*2650	*4800	4750	*6200	*6200	*9300	*9300				
		-1.5 m kg	*2900	*2900	*5050	4650	*6750	6500	*9550	*9550				
		-3.0 m kg	*3350	*3350	*4600	*4600	*6600	6450	*8950	*8950	*8150	*8150		
		-3.0 m kg	*4700	*4700			*5250	*5250	*7300	*7300				
		-4.5 m kg												
	2900 mm	7.5 m kg	*2550	*2550			*3450	*3450						
		4.5 m kg	*2300	*2300			*4150	*4150						
		3.0 m kg	*2200	*2200	*3900	*3900	*4700	*4700	*4550	*4550				
		1.5 m kg	*2200	*2200	*4400	*4400	*5550	*5550	*7550	*7550				
		0.0 m kg	*2300	*2300	*4650	*4650	*6050	*6050	*8850	*8850				
		-1.5 m kg	*2450	*2450	*4900	4600	*6600	6450	*9550	*9550	*4900	*4900		
		-3.0 m kg	*2850	*2850	*4900	4600	*6650	6350	*9050	*9050	*7700	*7700		
		-3.0 m kg	*4150	*4150			*5550	*5550	*7650	*7650				
		-4.5 m kg												



- A – Reach from swing center
- B – Bucket hook height
- C – Lifting capacities, including bucket linkage (120 kg) and bucket cylinder (109 kg)

When removing linkage or cylinder, lifting capacities can be increased by their respective weights.

* Load is limited by hydraulic capacity rather than tipping. Ratings are based on ISO standard 10567. Rated loads do not exceed 87% of hydraulic lift capacity or 75% of tipping load.

-  – Rating over front
-  – Rating over side
-  – Rating at maximum reach

Standard and optional equipment

Engine

Komatsu SAA6D107E-3 turbocharged common rail direct injection diesel engine	●
EU Stage V compliant	●
Suction type cooling fan	●
Automatic engine warm-up system	●
Engine overheat prevention system	●
Auto-deceleration function	●
Adjustable idle shutdown	●
Engine ignition can be password secured on request	●
Batteries 2 × 12 V / 125 Ah	●
Alternator 24 V / 90 A	●
Starter motor 24 V / 5.5 kW	●

Hydraulic system

Electronic closed-centre load sensing (E-CLSS) hydraulic system (HydraMind)	●
Pump and engine mutual control (PEMC) system	●
6-working mode selection system; Power, Lifting/Fine Operation, Breaker, Economy, Attachment Power and Attachment Economy	●
PowerMax function	●
Adjustable PPC wrist control levers for arm, boom, bucket and swing, with sliding proportional control for attachments and 5 auxiliary buttons, with FNR switch	●
Additional hydraulic circuit (HCU-B)	●
Additional hydraulic circuit (HCU-C)	○
Extension HCU-C to HCU-D	○
Komatsu Integrated Attachment Control (KIAC)	○
Boom suspension system (ECSS)	○
Prepared for hydraulic quick-coupler	○

Undercarriage

Parallel blade (front and/or rear) with cylinder protection	○
2 or 4 outriggers with cylinder protection, individually adjustable	○
Limited-slip differential (LSD)	○
Twin tyres 10.00-20 16 PR	○
Twin tyres (solid tyres) 10.00-20	○
Twin tyres 315/70 R22.5	○
Single tyres 445/70 R19.5	○
Single tyres 710/40 22.5	○
Trailer hitches	○
Fenders	○

Cabin

SpaceCab™, ROPS, Highly pressurised and tightly sealed hyper viscous mounted cab with tinted safety glass windows, large roof window with sun shade, pull-up type front window with locking device, removable lower window, front window wiper with intermittent feature, sun roller blind, cigarette lighter, luggage shelf, floor mat	●
Heated air suspension seat with lumbar support, arm rests and retractable seat belt	●
Automatic climate control system	●
12/24 Volt power supplies	●
Beverage holder and magazine rack	●
Hot and cool box	●
Adjustable steering column	●
Premium comfort seat	○
DAB+ radio with Bluetooth®, USB, AUX and hands-free kit	○
Heated, adjustable, suspended seat	○
Lower wiper	○
Rain visor (not with OPG)	○
Joystick steering system	○

Safety equipment

KomVision surround view system	●
Electric horn	●
Overload warning device	●
Lockable fuel cap and covers	●
Audible travel alarm	●
Large handrails, rear-view mirrors	●
Battery main switch	●
Boom safety valves	●
Arm safety valve	●
Adjust cylinder safety valve	●
OPG Level II front guard (FOPS)	○
OPG Level II top guard (FOPS)	○
Audible travel alarm (white noise version)	○

Lighting system

Standard halogen working lights package	●
LED working lights package	○
Advanced LED working lights package	○
Beacon	○

Service and maintenance

Automatic fuel line de-aeration	●
Double element type air cleaner with dust indicator and auto dust evacuator	●
Komtrax – Komatsu wireless monitoring system (4G)	●
Multifunction video compatible colour monitor with Equipment Management and Monitoring System (EMMS) and efficiency guidance	●
Toolkit	●
Komatsu Care – a maintenance program for Komatsu customers	●
Remote greasing bar	●
Automatic greasing system	○

Drives and brakes

Fully automatic 3-speed transmission driving through front and rear planetary axles	●
Oscillating front axle (10°) with automatic and manual cylinder locking	●
Cruise control	●
2.55 m wide undercarriage	●
2.75 m wide undercarriage	○
20, 25 or 35 km/h speed limitation	○
Transmission guard	○
Automatic digging brake	○

Work equipment

Mono boom	○
Two-piece boom	○
2250 mm; 2600 mm; 2900 mm arms	○
Clamshell grip bar	○
Lehnhoff quick-couplers	○
Lehnhoff buckets	○

Other equipment

Standard counterweight	●
Electric refuelling pump with automatic shut-off function	●
Single chassis tool box	●
Additional chassis tool box	○
Biodegradable oil for hydraulic system	○
Customised paint	○
License plate holder	○

Further equipment on request

- standard equipment
- optional equipment

This specification sheet may contain attachments and optional equipment that are not available in your area. Please consult your local Komatsu distributor for those items you may require. Materials and specifications are subject to change without notice.

Your Komatsu partner:

KOMATSU

[komatsu.eu](https://www.komatsu.eu)

